



Super Copa de Espana Junior Gijon 2023

Gijon (AST), 26 Nov 2023

-60 kg
44 Judoka

POOL A

1	PEREZ ROLDAN, Jaime	AND
33		
17	VILLALBA MARTIN, Rodrigo	AST
49	BORGHES SHI, Daniel	AST
41	BARBEITO SANJURJO, Marti	GAL
25		
57	ORTIZ SOLANA, Dario	CTB
5		
37	GONZALEZ LOPEZ, Hugo	AST
21	CERNUDA SANTAMARINA, LG	LAN
53	VAQUERO JIMENEZ, Alvaro	MAD
13	FERNANDEZ BARJOLA, Diego	CAS
45	GUSANO GONZALEZ, Aimar	NAV
29		
61	CEACERO CEBOLLA, Fernando	VAL

1	PEREZ ROLDAN, Jaime	33
2	VILLALBA MARTIN, Rodrigo	49
3	BORGHES SHI, Daniel	41
4	ORTIZ SOLANA, Dario	25
5	GONZALEZ LOPEZ, Hugo	37
6	CERNUDA SANTAMARINA, LG	53
7	VAQUERO JIMENEZ, Alvaro	13
8	FERNANDEZ BARJOLA, Diego	45
9	GUSANO GONZALEZ, Aimar	29
10	CEACERO CEBOLLA, Fernando	61

POOL A Winner / Ganador
Vainqueur / Sieger

POOL B

3	GARCIA SUAREZ, Alejandro	CAN
35		
19	SANTAMARIA GONZALEZ, LG	CAS
51	LLAMAS VIEJO, Alex	CAT
11	CAMUNA MARTINEZ, Guillermo	AST
43	GARCIA CORRAL, Pablo	EXT
27		
59	GUERRERO CORTES, Miche	CTB
7	GIL BENDICHO, Carlos	MAD
39		
23	RODRIGUEZ DAVINA, Alberto	GAL
55	DIAZ GOMEZ, Pelayo	AST
15		
47	SADABA CORBACHO, Peio	VAS
31		
63	FERNANDEZ ALVAREZ, Jorge	AST

9	GARCIA SUAREZ, Alejandro	37
10	LLAMAS VIEJO, Alex	51
11	CAMUNA MARTINEZ, Guillermo	43
12	GUERRERO CORTES, Miche	27
13	GIL BENDICHO, Carlos	39
14	RODRIGUEZ DAVINA, Alberto	55
15	DIAZ GOMEZ, Pelayo	15
16	SADABA CORBACHO, Peio	47
17	FERNANDEZ ALVAREZ, Jorge	31

POOL B Winner / Ganador
Vainqueur / Sieger

POOL C

2	CERVANTES GARCIA, Daniel	NAV
34		
18	MEÑEZ MEÑEZ, Unax	VAS
50	CASTRO LOPEZ, Esteban	GAL
10	UTRERO CRESPO, Iker	MAD
42	GAMBA ANTUNA, Alvaro	AST
26	PENAS MERINO, Unai	GAL
58		
6	MUNOZ GUERRERO, Julen	CAT
38		
22		
54	BERMUDEZ FERNANDEZ, Sergio	AST
14		
46	GARCIA RODRIGUEZ, Hugo	CTB
30	JANISZEWSKI LEMUS, Luca	GAL
62	SANCHEZ GARCIA, Ivan	AND

17	CERVANTES GARCIA, Daniel	41
18	MEÑEZ MEÑEZ, Unax	50
19	UTRERO CRESPO, Iker	42
20	PENAS MERINO, Unai	26
21	MUNOZ GUERRERO, Julen	38
22	BERMUDEZ FERNANDEZ, Sergio	54
23	GARCIA RODRIGUEZ, Hugo	46
24	JANISZEWSKI LEMUS, Luca	30
25	SANCHEZ GARCIA, Ivan	62

POOL C Winner / Ganador
Vainqueur / Sieger

POOL D

4	FERNANDEZ DE LA IGLESIA, David	CAN
36		
20	SANCHEZ. COSTA, Mario	CTB
12		
44	DE LA TORRE FERNANDEZ, Aitor	VAS
28	TORRES CAPARROS, Dario	AND
60	GARCIA IGLESIAS, Iyan	AST
8	ROSADO LOPEZ, Rodrigo	VAL
40		
24	GUTIERREZ ALDAMA, Migue	AST
56	LARRAMENDI BALLADARES, Galgo	GAL
16		
48	PEREZ PRADO, Diego	AST
32	SANZ AVILA, Daniel	MAD
64	LOPEZ VEGA, Endika	VAS

25	FERNANDEZ DE LA IGLESIA, David	45
26	SANCHEZ. COSTA, Mario	12
27	DE LA TORRE FERNANDEZ, Aitor	44
28	TORRES CAPARROS, Dario	28
29	ROSADO LOPEZ, Rodrigo	40
30	GUTIERREZ ALDAMA, Migue	56
31	PEREZ PRADO, Diego	48
32	SANZ AVILA, Daniel	64
33	LOPEZ VEGA, Endika	64

POOL D Winner / Ganador
Vainqueur / Sieger

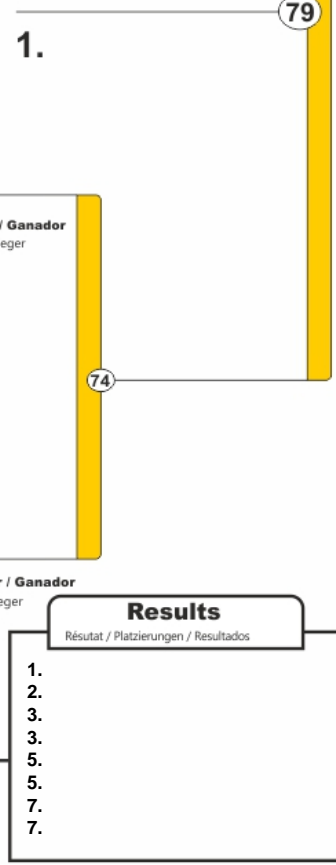

Trostrunde / Repechage / Ronda de consolación

Repechage / Trostrunde / Repechage

[A1]	
[A2]	61
[B1]	
[B2]	62
[C1]	
[C2]	63
[D1]	
[D2]	64

[A3]	65
[A4]	69
[B3]	66
[B4]	70
[C3]	67
[C4]	71
[D3]	68
[D4]	72

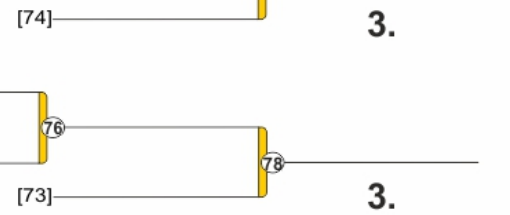



Super Copa de Espana Junior Gijon 2023

Gijon (AST), 26 Nov 2023

-66 kg
56 Judoka

POOL A

1	SEDANO CASTELLS, Luis	VAL	1	SEDANO CASTELLS, Luis
33			33	
17	PIZARRO ARIAS, Daniel	AST	2	
49	PIZARRO CASAS, Carlos	MAD	2	
9	RODRIGUEZ GALACHE, Hector	GLE	3	
41	RODRIGUEZ FERNANDEZ, Alberto	AST	3	
25	PELLON LINERO, Guillermo	CTB	4	
57	ROMAY PRUNEDA, Adriel	AST	4	
5	TECEDOR OLLORA, Marcos	RIO	5	TECEDOR OLLORA, Marcos
37			57	
21	TAMARGO ALVAREZ, Lucas	AST	6	
53	NOGAROL FERRER, Daniel	ARA	6	
13	PERAU PERRAMON, Jan	CAT	7	
45	GALLARDO CRUZ, Marcos	AND	7	
29	LYSOGOR CHERKESOV, Maxim	MAD	8	
61	SIEIRO VAZQUEZ, Pablo	GAL	8	

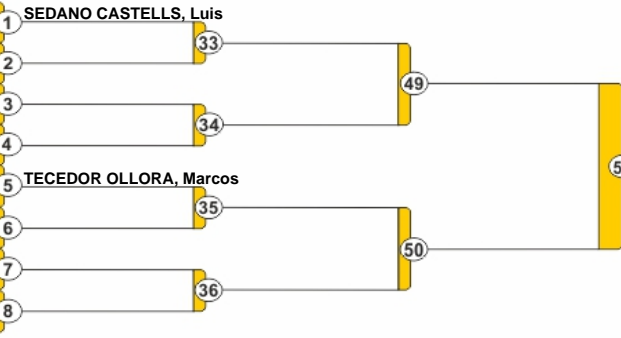

POOL A Winner / Ganador
Vainqueur / Sieger

POOL B

3	MARTIN LOBO, Daniel	MAD	9	MARTIN LOBO, Daniel
35			35	
19	RIBERA MARTINEZ, Marcos	VAL	10	
51	COVIELLA MUNOZ, Diego	AST	10	
11	BORGHES SHI, Pau	AST	11	
43	FRANCISCO RUIZ, Angel	GAL	11	
27	QUEIJA PASCOAL, Unai	MUR	12	
59	MOLINA CANESTRO, Alejandro	AND	12	
7	GONZALEZ GOMEZ, Roberto	MAD	13	GONZALEZ GOMEZ, Roberto
39			39	
23	EXPOSITO GONZALEZ, Cesar	CTB	14	
55	GOLUBEV, Gleb	VAS	14	
15	LOPEZ RIVERA, Diego	GAL	15	
47	SANCHA ANTEQUERA, Hector	VAL	15	
31	HERRERO MARTINEZ, Samuel	AST	16	
63	URBINA RIVERA, Emiliano	ARA	16	

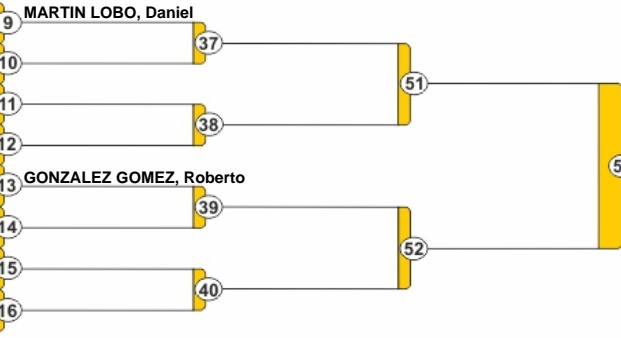

POOL B Winner / Ganador
Vainqueur / Sieger

POOL C

2	TERES CEREZA, Hugo	ARA	17	TERES CEREZA, Hugo
34			34	
18	BENITO, Jordi	CAT	18	
50	MADRID GARCIA, Lucas	AST	18	
10	ROYO RUBIO, Sergio Yeray	GAL	19	
42	CARAZO LACUNZA, Julio	MAD	19	
26	JIMENEZ LOPEZ, David	CAN	20	
58	GAMEZ RODRIGUEZ, Javier	AND	20	
6	NOVILLO MANTECON, Victor	MAD	21	NOVILLO MANTECON, Victor
38			38	
22	ALVAREZ VELENCOSO, Felix	VAL	22	
54	ALONSO AZCARATE, Pablo	AST	22	
14	SOUSA LAVANDEIRA, Breixo	GAL	23	
46	SERRANO MARTINEZ, Marco	AST	23	
30	LABAJOS GARCIA, Diego	CTB	24	
62	DE PEDRO CUADRADO, Mar	GLE	24	

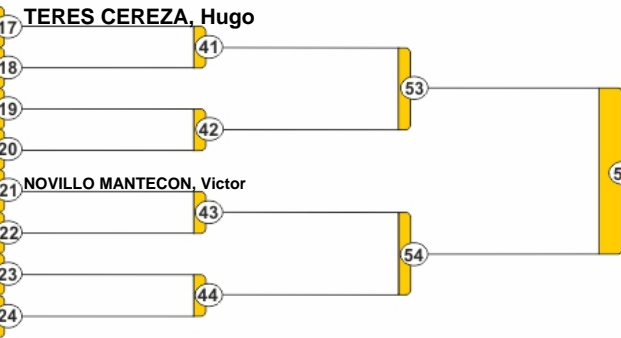

POOL C Winner / Ganador
Vainqueur / Sieger

POOL D

4	VEGA MUNIZ, Iker	CTB	25	VEGA MUNIZ, Iker
36			36	
20	GUTIERREZ FERNANDEZ, Ili	AST	26	
52	VILA FERREIRO, Eduardo	GAL	26	
12	MURILLO BALDOMINOS, Dav	ARA	27	
44	CARRODEGUAS DIAZ, Bruna	GAL	27	
28	TARIKET, Hamza	VAL	28	
60	MENDAZONA LABERNA, Dav	VAS	28	
8	DIENG ALVAREZ, Khadime Bamba	GBA	29	DIENG ALVAREZ, Khadime Bamba
40			40	
24	GAMEZ RODRIGUEZ, Antoni	AND	30	
56	KUCHURYANU, Pavorio	RIO	30	
16	ALONSO BEZANILLA, Julio	CTB	31	
48	AVELLO JUARRERO, Jorge	AST	31	
32	LLAGOSTERA GARCIA-SETI	MAD	32	
64	GADEA JUAN, Borja	VAL	32	

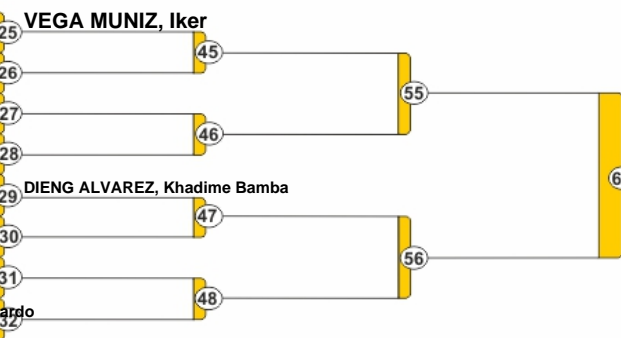

POOL D Winner / Ganador
Vainqueur / Sieger

Results
Résultat / Platzierungen / Resultados

- 1.
- 2.
- 3.
- 3.
- 5.
- 5.
- 7.
- 7.

Trostrunde / Repechage / Ronda de consolación

Repechage / Trostrunde / Repechage

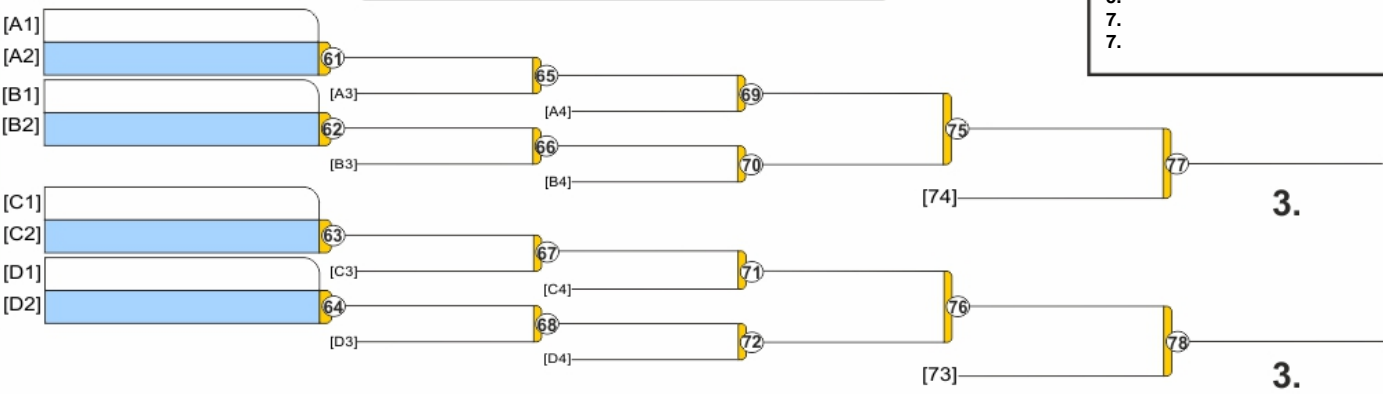



Super Copa de Espana Junior Gijon 2023

Gijon (AST), 26 Nov 2023

-73 kg
53 Judoka

POOL A

1	FERNANDEZ BOU, Carlos	VAL
33	CABANAS GRANDE, Marcos	MAD
49	ARES SEJIDO, Carlos Javier	GAL
9	LUCAS CAMPOS, Miguel	MUR
41	PADILLA MARTIN, Enol	AST
25	RUBIO IGLESIAS, Rafael	AND
57	COLINA HERNANDEZ, Igor	VAS
37	HREBENYK SAVCHAK, Dani	MAD
53	DUARTE, Junior	POR
13	ORTIZ DURAN, Ibai	MAD
45	PATINO HERRERO, Alejandro	GAL
29	MARIN PIFARRE, Adria	CAT
61	GALLEGO RODRIGUEZ, Eno	AST

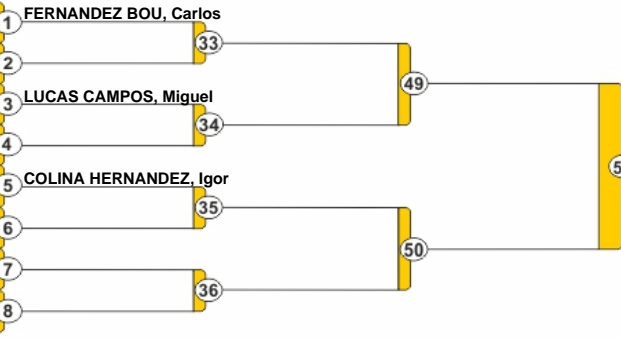

POOL A Winner / Ganador
Vainqueur / Sieger

POOL B

3	MARTINEZ ESPINOSA, Javier	CAT
35	FERNANDEZ SAINZ, Raul	MAD
19	MARTIN GAGO, Adrian	GAL
51	SUAREZ CORRALES, Nel	AST
11	RUBIO HERNANDEZ, Daniel	AND
43	FERNANDEZ LOPEZ, Raul	MAD
27	CEJALVO ALJAMA, Andres	ARA
59	GONZALEZ GARCIA, Francisco	EXT
7	MARTINEZ SANTIAGO, Ma	MAD
39	ARENAS JARA, Guillermo	FEB
23	BLANCO GARCIA, Eduardo	MAD
55	SANTOS MORALES, Rodrigo	AST
15	COCA ANTON, Iker	CLE
47		
31		
63		

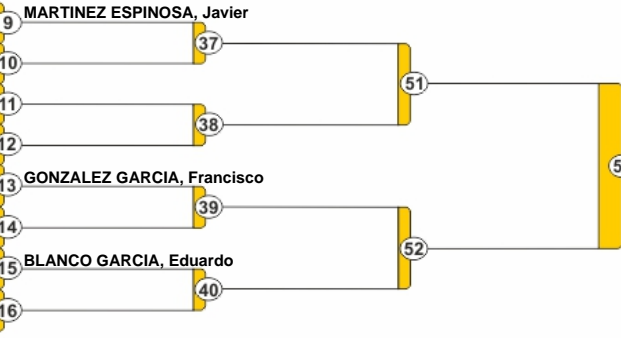

POOL B Winner / Ganador
Vainqueur / Sieger

POOL C

2	SANUDO SAMPERIO, Marco	CTB
34	TENREIRO LEIRA, Mario	GAL
18	SALA CANO, Alejandro	VAL
50	RUIZ MANUECO, Juan	AST
10	PINON MORAL, Jorge	MAD
42	AGUINAGA URZELAI, Xabier	VAS
26	IGLESIAS PASCUAL, Ruben	MUR
58	RODRIGUEZ FARALDO, Mateo	GAL
6	HIDALGO CLAUSIN, Alex	CAT
38	RUIZ CARRACEDO, Inaki	MAD
22	IGLESIAS ALVAREZ, Alvaro	AST
54	DIAZ HERRADOR, Mario	CLM
14	ORTIZ RUEDA, David	EXT
46	FERNANDEZ SAINZ, Angel	MAD
30		
62		

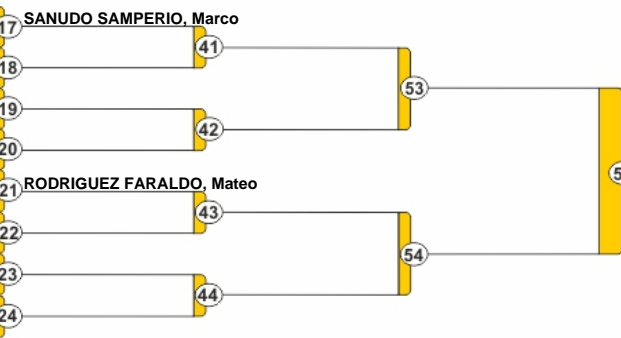

POOL C Winner / Ganador
Vainqueur / Sieger

POOL D

4	MSSAHAL HASSAD, Ahmed	CAT
36	GOMEZ CASES, Asier	VAL
20	CORNIDE CHINCHON, Sergi	MAD
52	SOLIS MERE, Gabriel	AST
12	GOMEZ MORALES, Jorge	AND
44	CASTRO PATINO, Martin Ilic	GAL
28	BERROCAL CABALLERO, Alvaro	MAD
60	SUAREZ MEDINA, Bayron Andres	MAD
8	GUTIERREZ MIRANDA, Carlos	AND
40	SANCHEZ ALVAREZ, Miguel	AST
24	CASTEDO TRASHORRAS, Carlos	GAL
56	MATEOS SANCHEZ, Alonso	MAD
16	NAVAL AVILA, Andoni	VAS
48		
32		
64		

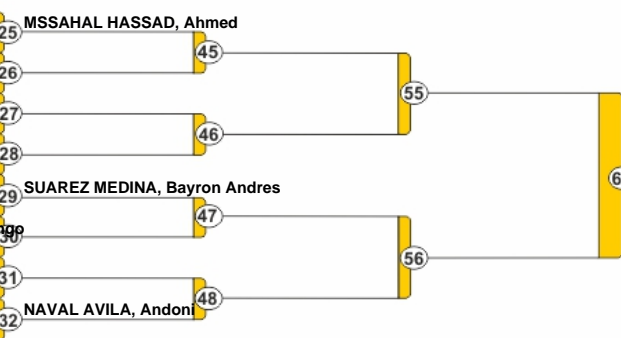

POOL D Winner / Ganador
Vainqueur / Sieger

1. 79

74

73

58

57

50

36

35

34

33

37

38

39

40

41

42

43

44

45

46

47

48

49

50

51

52

53

54

55

56

57

58

59

60

61

62

63

64

65

66

67

68

69

70

71

72

73

74

75

76

77

78

79

80

81

82

83

84

85

86

87

88

89

90

91

92

93

94

95

96

97

98

99

100

101

102

103

104

105

106

107

108

109

110

111

112

113

114

115

116

117

118

119

120

121

122

123

124

125

126

127

128

129

130

131

132

133

134

135

136

137

138

139

140

141

142

143

144

145

146

147

148

149

150

151

152

153

154

155

156

157

158

159

160

161

162

163

164

165

166

167

168

169

170

171

172

173

174

175

176

177

178

179

180

181

182

183

184

185

186

187

188

189

190

191

192

193

194

195

196

197

198

199

200

201

202

203

204

205

206

207

208

209

210

211

212

213

214

215

216

217

218

219

220

221

222

223

224

225

226

227

228

229

230

231

232

233

234

235

236

237

238

239

240

241

242

243

244

245

246

247

248

249

250

251

252

253

254

255

256

257

258

259

260

261

262

263

264

265

266

267

268

269

270

271

272

273

274

275

276

277

278

279

280

281

282

283

284

285

286

287

288

289

290

291

292

293

294

295

296

297

298

299

300

301

302

303

304

305

306

307

308

309

310

311

312

313

314

315

316

317

318

319

320

321

322

323

324

325

326

327

328

329

330

331

332

333

334

335

336

337

338

339

340

341

342

343

344

345

346

347

348

349

350

351

352

353

354

355

356

357

358

359

360

361

362

363

364

365

366

367

368

369

370

371

372

373

374

375

376

377

378

379

380

381

382

383

384

385

386

387

388

389

390

391

392

393

394

395

396

397

398

399

400

401

402

403

404

405

406

407

408

409

410

411

412

413

414

415

416

417

418

419

420

421

422

423

424

425

426

427

428

429

430

431

432

433

434

435

436

437

438

439

440

441

442

443

444

445

446

447

448

449

450

451

452

453

454

455

456

457

458

459

460

461

462

463

464

465

466

467

468

469

470

471

472

473

474

475

476

477

478

479

480

481

482

483

484

485

486

487

488

489

490

491

492

493

494

495

496

497

498

499

500

501

502

503

504

505

506

507

508

509

510

511

512

513

514

515

516

517

518

519

520

521

522

523

524

525

526

527

528

529

530

531

532

533

534

535

536

537

538

539

540

541

542

543

544

545

546

547

548

549

550

551

552

553

554

555

556

557

558

559

560

561

562

563

564

565

566

567

568

569

570

571

572

573

574

575

576

577

578

579

580

581

582

583

584

585

586

587

588

589

590

591

592

593

594

595

596

597

598

599

600

601

602

603

604

605

606

607

608

609

610

611

612

613

614

615

616

617

618

619

620

621

622

623

624

625

626

627

628

629

630

631

632

633

634

635

636

637

638

639

640

641

642

643

644

645

646

647

648

649

650

651

652

653

654

655

656

657

658

659

660

661

662

663

664

665

666

667

668

669

670

671

672

673

674

675

676

677

678

679

680

681

682

683

684

685

686

687

688

689

690

691

692

693

694

695

696

697

698

699

700

701

702

703

704

705

706

707

708

709

710

711

712

713

714

715

716

717

718

719

720

721

722

723

724

725

726

727

728

729

730

731

732

733

734

735

736

737

738

739

740

741

742

743

744

745

746

747

748

749

750

751

752

753

754

755

756

757

758

759

760

761

762

763

764

765

766

767

768

769

770

771

772

773

774

775

776

777

778

779

780

781

782

783

784

785

786

787

788

789

790

791

792

793

794

795

796

797

798

799

800

801

802

803

804

805

806

807

808

809

810

811

812

813

814

815

816

817

818

819

820

821

822

823

824

825

826

827

828

829

830

831

832

833

834

835

836

837

838

839

840

841

842

843

844

845

846

847

848

849

850

851

852

853

854

855

856

857

858

859

860

861

862

863

864

865

866

867

868

869

870

871

872

873

874

875

876

877

878

879

880

881

882

883

884

885

886

887

888

889

890

891

892

893

894

895

896

897

898

899

900

901

902

903

904

905

906

907

908

909

910

911

912

913

914

915

916

917

918

919

920

921

922

923

924

925

926

927

928

929

930

931

932

933

934

935

936

937

938

939

940

941

942

943

944

945

946

947

948

949

950

951

952

953

954

955

956

957

958

959

960

961

962

963

964

965

966

967

968

969

970

971

972

973

974

975

976

977

978

979

980

981

982

983

984

985

986

987

988

989

990

991

992

993

994

995

996

997

998

999

1000

Trostrunde / Repechage / Ronda de consolación

Repechage / Trostrunde / Repechage

[A1]		
[A2]		
[B1]		
[B2]		
[C1]		
[C2]		
[D1]		
[D2]		

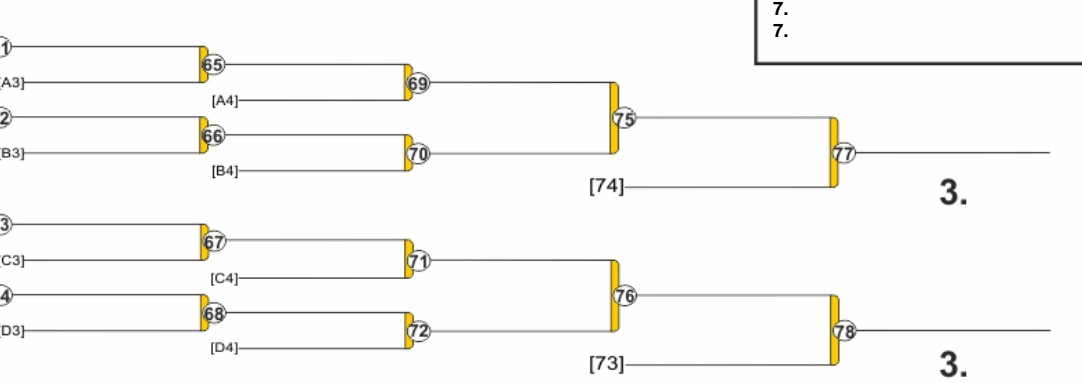

Results
Résultat / Platzierungen / Resultados

- 1.
- 2.
- 3.
- 3.
- 5.
- 5.
- 7.
- 7.



Super Copa de Espana Junior Gijon 2023

Gijon (AST), 26 Nov 2023

-81 kg
42 Judoka

POOL A

1	RAJ UDOVICHENKO, Ivan	GAL
33	NOTARIO COLLADO, Asier	CTB
49	CABEZAS RODRIGUEZ, Jaime	MAD
9	MARQUEZ SERRANO, Luis	EXT
41	GARCIA GARMENDIA, Migue	VAS
25	RUANO SANCHEZ, Flavio Jose	MUR
57	ARILLA NASARRE, Raul	ARA
37	FREIRE GONZALEZ, Nicolas	GAL
21	ALMEIDA, Filipe	POR
13	GONZALEZ RAMIREZ, Pablo	CAN
45	GONZALEZ RAMIREZ, Pablo	CAN
29	GONZALEZ SUAREZ, Pablo	AST
61	GONZALEZ SUAREZ, Pablo	AST

1	RAJ UDOVICHENKO, Ivan
33	NOTARIO COLLADO, Asier
2	CABEZAS RODRIGUEZ, Jaime
3	MARQUEZ SERRANO, Luis
4	GARCIA GARMENDIA, Migue
4	RUANO SANCHEZ, Flavio Jose
5	ARILLA NASARRE, Raul
6	FREIRE GONZALEZ, Nicolas
7	ALMEIDA, Filipe
8	GONZALEZ RAMIREZ, Pablo
8	GONZALEZ SUAREZ, Pablo

POOL B

3	ENERIZ GARCIA, Arkaitz	VAL
35	VILLABRILLE MERE, Luis	AST
19	MOURA, Ryan	POR
51	DOMINGUEZ MILAN, Arnau	CAT
11	GARCIA KHOLODOV, Maxim	ARA
43	HERGUIDO MILLON, Francisco	AND
27	HERGUIDO MILLON, Francisco	AND
59	QUIROGA PEREGRINA, Maria	AST
7	VITORES SOTA, Marcos	RIO
39	VITORES SOTA, Marcos	RIO
23	LOPEZ MOSQUERA, Brais	GAL
55	LOPEZ MOSQUERA, Brais	GAL
15	PALENZUELA GARRIDO, Sergio	MAD
47	PALENZUELA GARRIDO, Sergio	MAD
31	PALENZUELA GARRIDO, Sergio	MAD
63	PALENZUELA GARRIDO, Sergio	MAD

9	ENERIZ GARCIA, Arkaitz
10	VILLABRILLE MERE, Luis
11	MOURA, Ryan
12	GARCIA KHOLODOV, Maxim
13	HERGUIDO MILLON, Francisco
14	HERGUIDO MILLON, Francisco
14	QUIROGA PEREGRINA, Maria
15	VITORES SOTA, Marcos
15	LOPEZ MOSQUERA, Brais
16	PALENZUELA GARRIDO, Sergio

POOL C

2	ACHOUR ARTILES, Salem	CAN
34	MATINEZ-BUJANDA ALVAREZ, Ivan	CTB
18	TENRERO PASTOR, Jorge	PAL
50	CHIROSA MCCARTHY, Samuel	AND
10	ZARCO PEINADO, Rodrigo	CLM
42	GONZALEZ BLANCO, Ivan	AST
26	GONZALEZ BLANCO, Ivan	AST
58	DIAZ GUERRA, Roberto	CTB
6	DIAZ GUERRA, Roberto	CTB
38	FERNANDEZ ALBIOL, Julio	MAD
22	VICENTE GARDE, Roman	ARA
54	VICENTE GARDE, Roman	ARA
14	SERATILA, Daniel	POR
46	SERATILA, Daniel	POR
30	CARRASCO, Javier	GAL
62	CARRASCO, Javier	GAL

17	ACHOUR ARTILES, Salem
18	MATINEZ-BUJANDA ALVAREZ, Ivan
19	CHIROSA MCCARTHY, Samuel
20	ZARCO PEINADO, Rodrigo
21	DIAZ GUERRA, Roberto
22	FERNANDEZ ALBIOL, Julio
23	SERATILA, Daniel
24	CARRASCO, Javier

POOL D

4	CALVO SANCHEZ, Bruno	GAL
36	DAVTYAN VARDANYAN, Ruben	CAT
20	GARCIA ACEBAL, Nacho	AST
52	GONZALEZ PANZARI, Stephan	MUR
12	GONZALEZ PANZARI, Stephan	MUR
44	GONZALEZ HERRERA, Gustavo	ARA
28	GONZALEZ HERRERA, Gustavo	ARA
60	PATINO HERRERO, Nicolas	GAL
8	PATINO HERRERO, Nicolas	GAL
40	GIMENEZ CASTANO, Jairo	AND
24	ARISTEGUI AREVALO, Suha	VAS
56	ARISTEGUI AREVALO, Suha	VAS
16	BANQUERI SANCHEZ, Alejandro	MAD
48	BANQUERI SANCHEZ, Alejandro	MAD
32	BANQUERI SANCHEZ, Alejandro	MAD
64	MACK HARO, Din Richard	ARA

25	CALVO SANCHEZ, Bruno
26	DAVTYAN VARDANYAN, Ruben
27	GONZALEZ PANZARI, Stephan
28	GONZALEZ HERRERA, Gustavo
29	PATINO HERRERO, Nicolas
30	GIMENEZ CASTANO, Jairo
31	BANQUERI SANCHEZ, Alejandro
32	MACK HARO, Din Richard

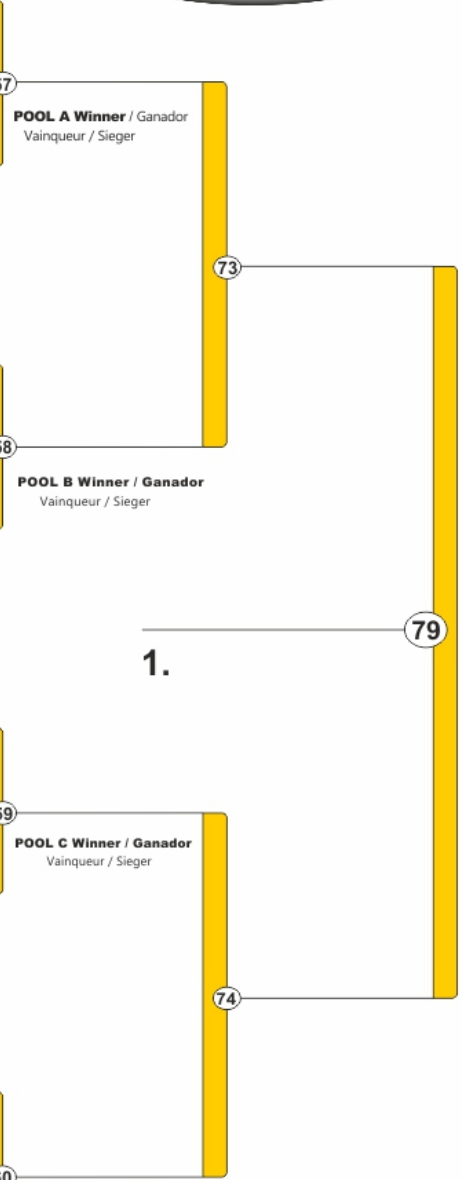

Trostrunde / Repechage / Ronda de consolación

Repechage

[A1]	
[A2]	61
[B1]	[A3]
[B2]	62
	[B3]
[C1]	[B4]
[C2]	63
[D1]	[C3]
[D2]	64
	[D3]

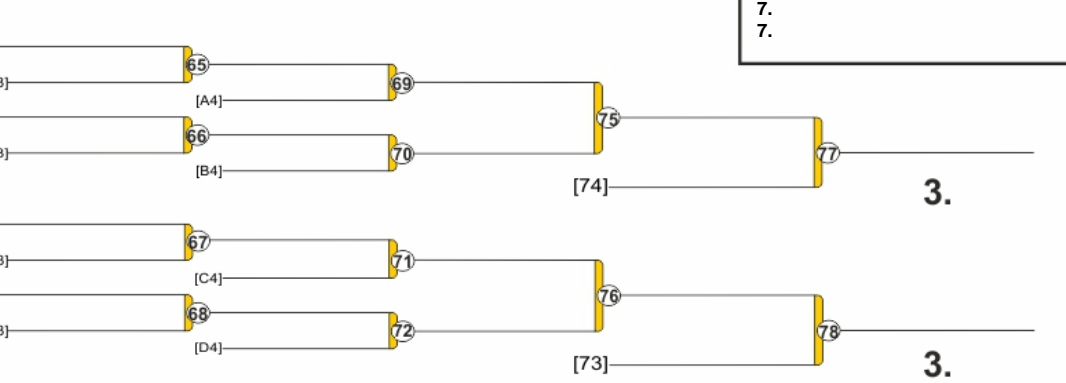

Results	
Résultat / Platzierungen / Resultados	
1.	
2.	
3.	
3.	
5.	
5.	
7.	
7.	



Super Copa de Espana Junior Gijon 2023

Gijon (AST), 26 Nov 2023

-90 kg

16 Judoka

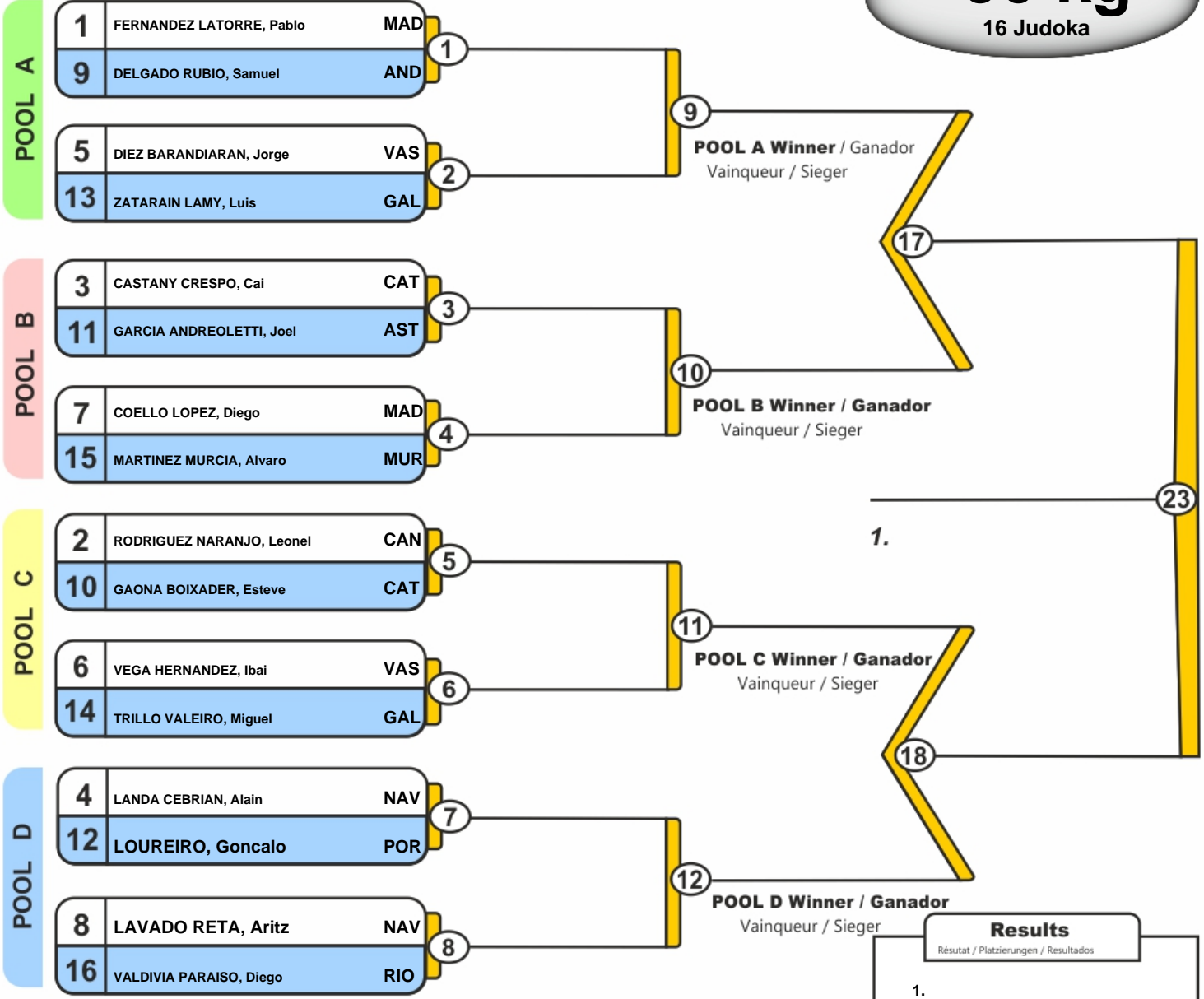

Trostrunde / Repechage / Ronda de consolación

Results	
Résultat / Platzierungen / Resultados	
1.	
2.	
3.	
3.	
5.	
7.	
7.	

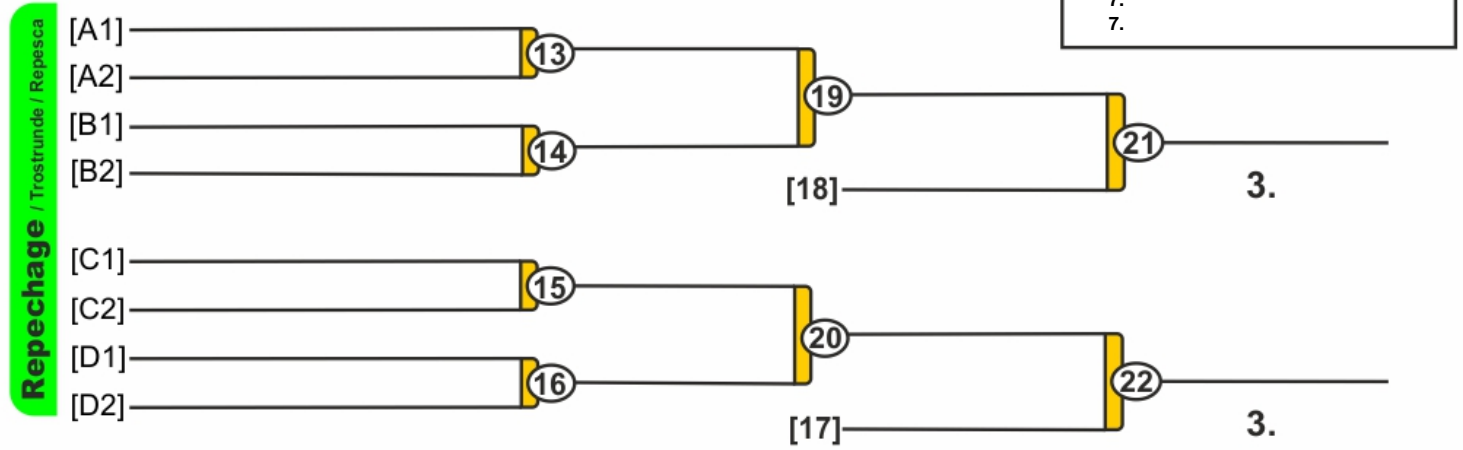



Super Copa de Espana Junior Gijon 2023

Gijon (AST), 26 Nov 2023

-100 kg
6 Judoka

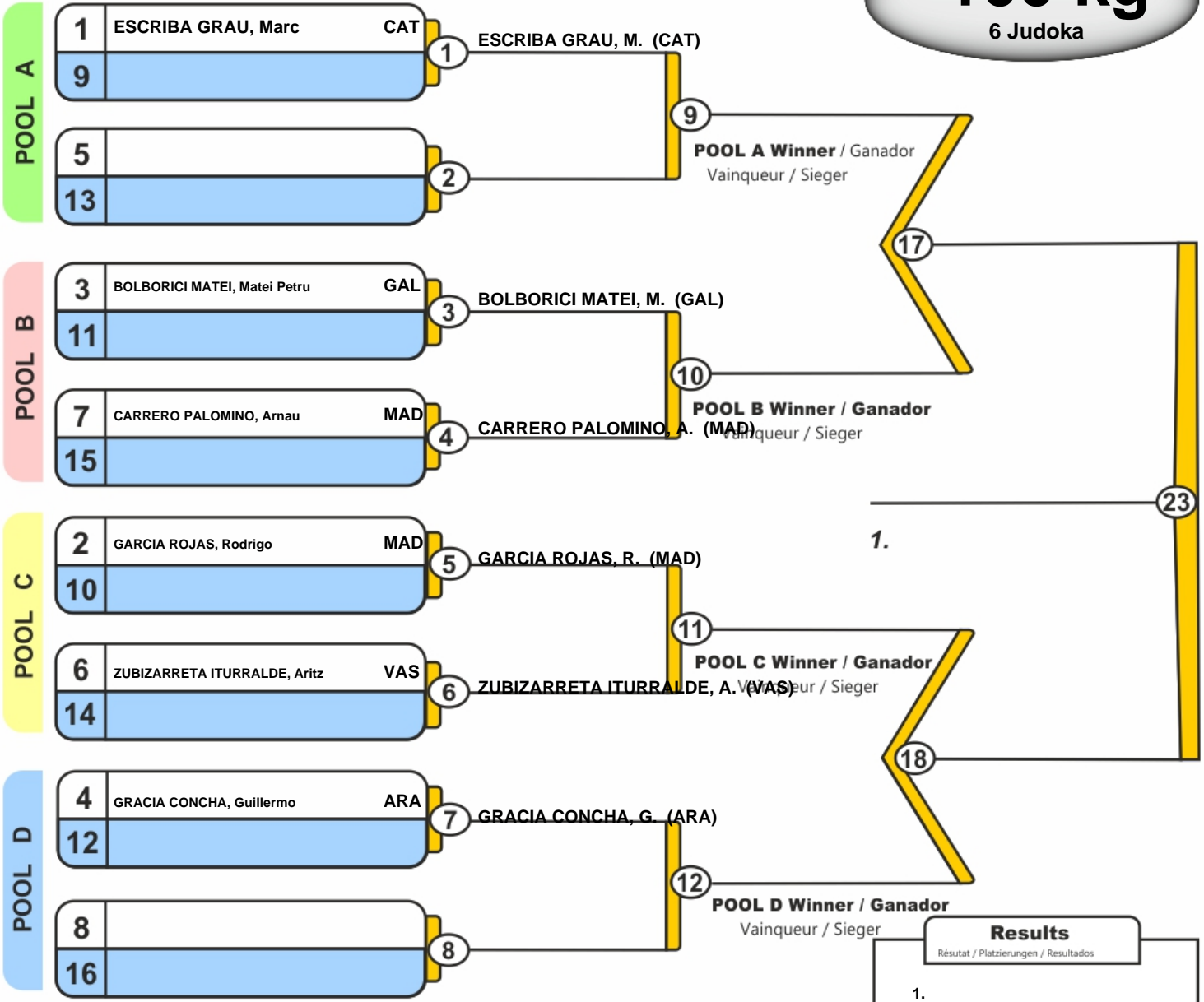

Trostrunde / Repechage / Ronda de consolación

Results	
Résultat / Platzierungen / Resultados	
1.	
2.	
3.	
3.	
5.	
7.	
7.	

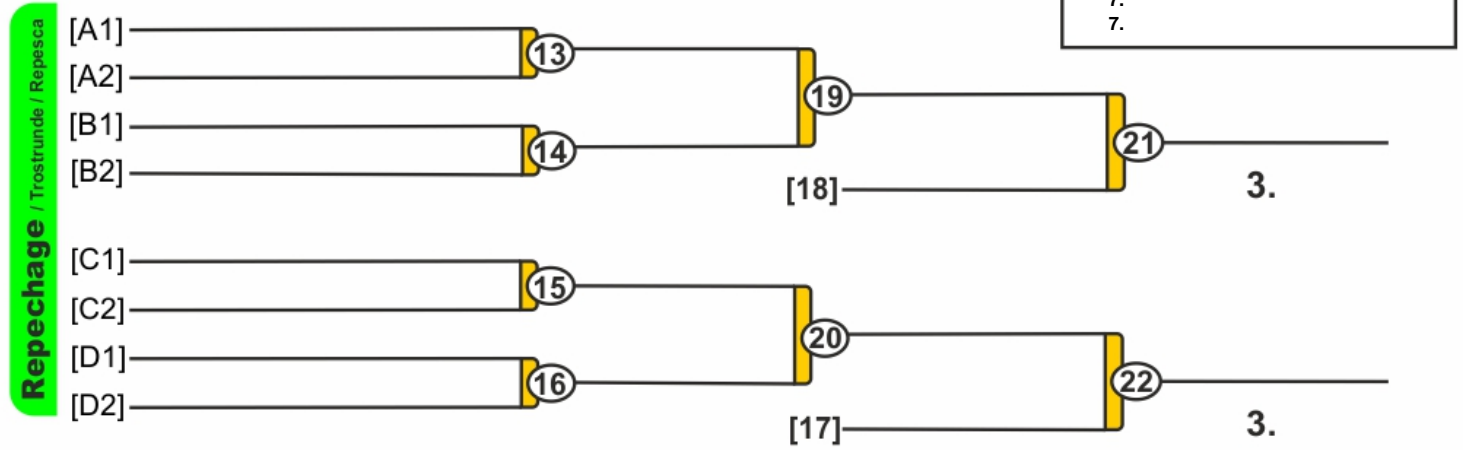



Super Copa de Espana Junior Gijon 2023

Gijon (AST), 26 Nov 2023

+100 kg

7 Judoka

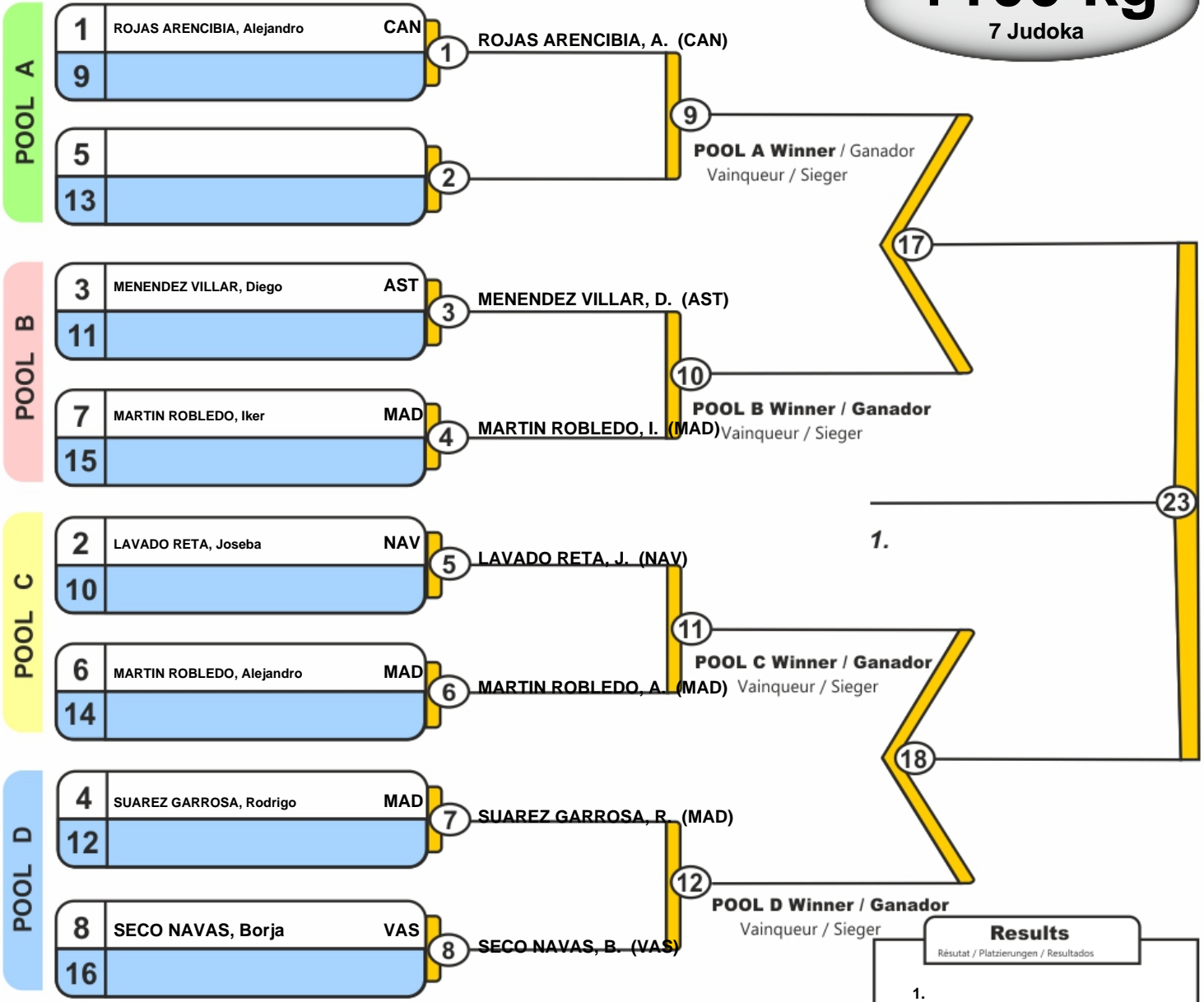

Trostrunde / Repechage / Ronda de consolación

Results	
Résultat / Platzierungen / Resultados	
1.	
2.	
3.	
3.	
5.	
7.	
7.	

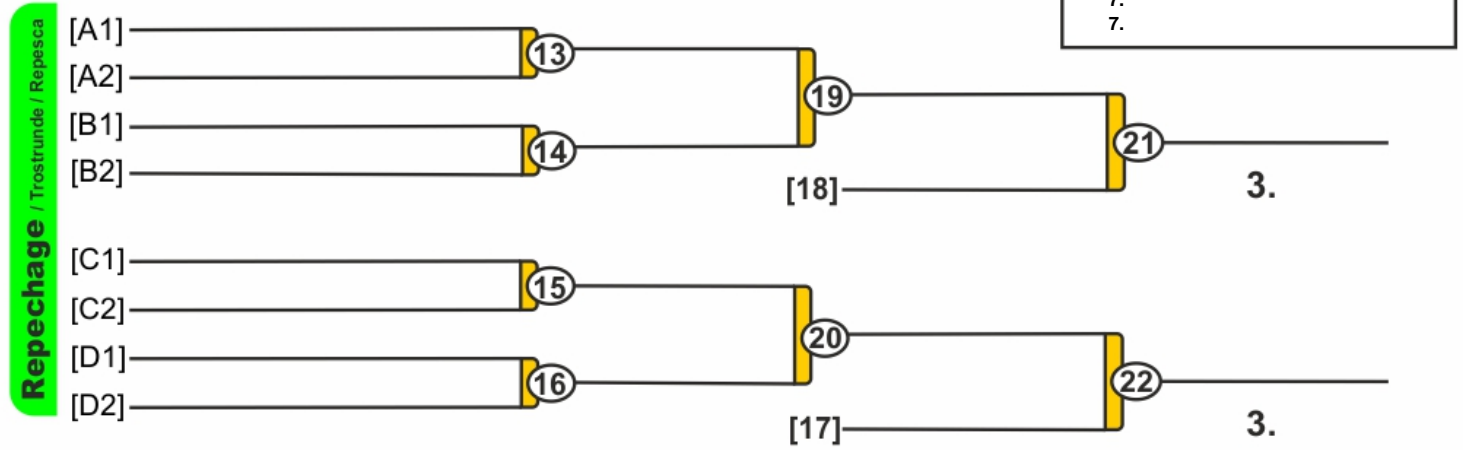



Super Copa de Espana Junior Gijon 2023

Gijon (AST), 26 Nov 2023

-48 kg

19 Judoka

POOL A

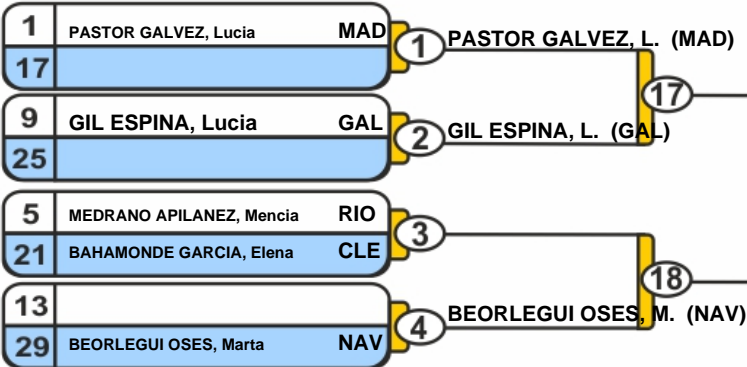

POOL A Winner / Ganador
Vainqueur / Sieger

POOL B

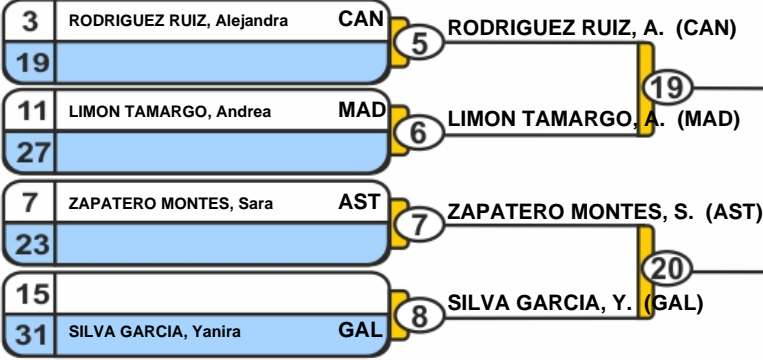

POOL B Winner / Ganador
Vainqueur / Sieger

POOL C

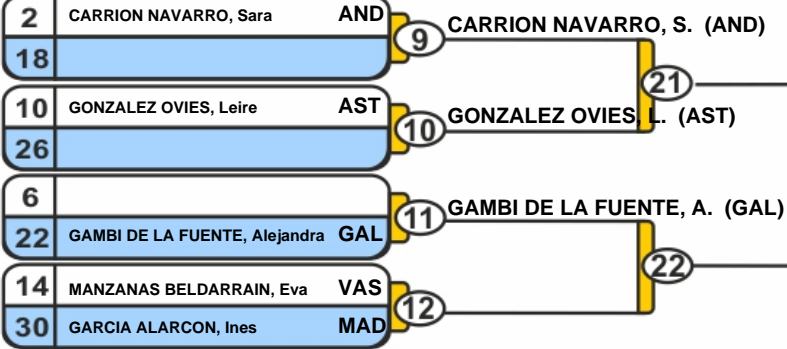

POOL C Winner / Ganador
Vainqueur / Sieger

POOL D

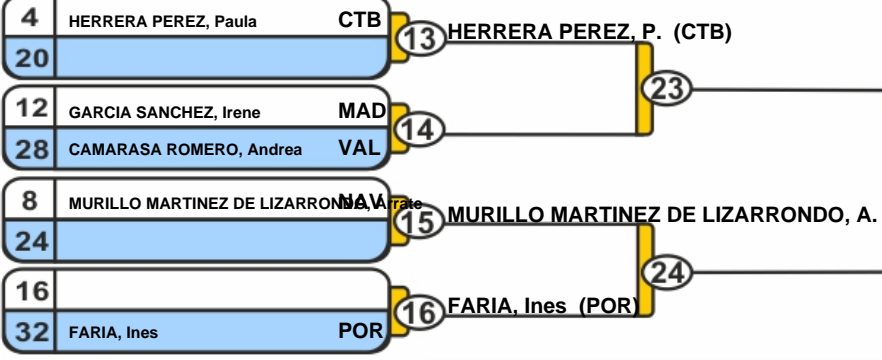

POOL D Winner / Ganador
Vainqueur / Sieger

1.

43

Results

Résultat / Platzierungen / Resultados

- 1.
- 2.
- 3.
- 3.
- 5.
- 5.
- 7.
- 7.

Trostrunde / Repechage / Ronda de consolación

Repechage

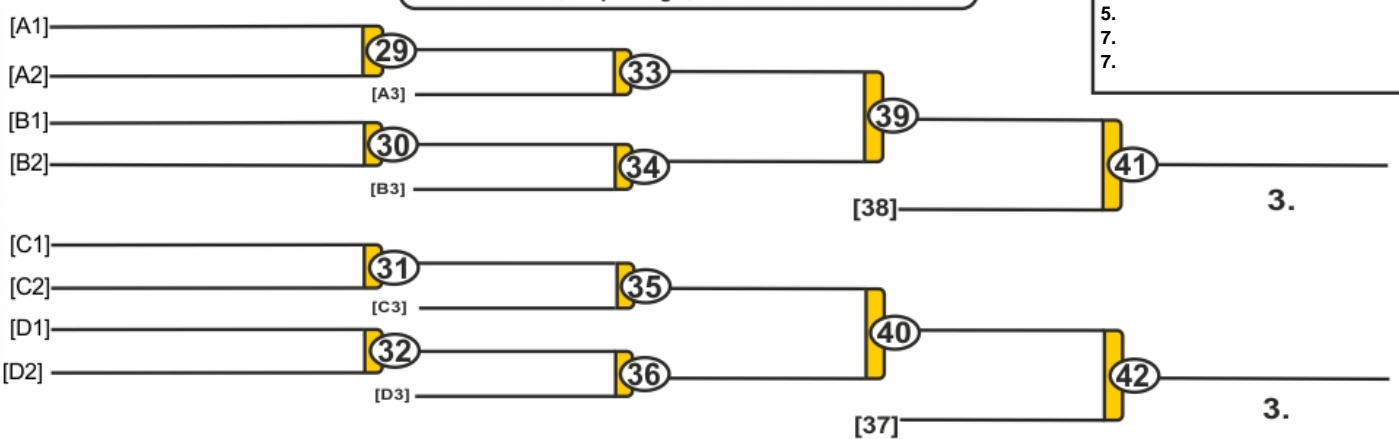



Super Copa de Espana Junior Gijon 2023

Gijon (AST), 26 Nov 2023

-52 kg

24 Judoka

POOL A

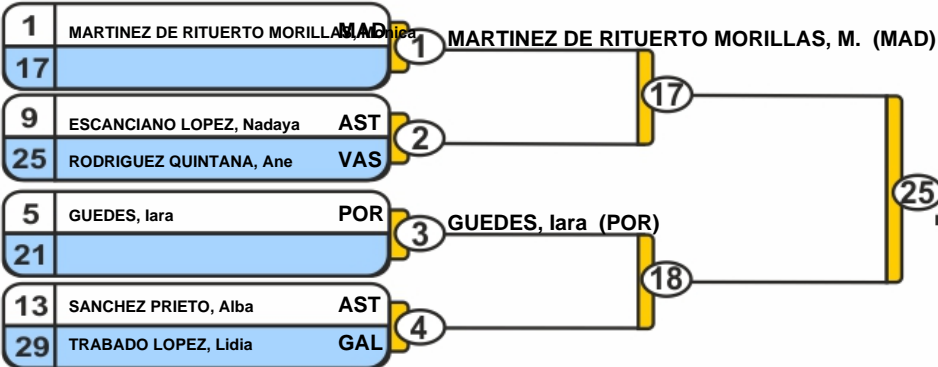

POOL A Winner / Ganador
Vainqueur / Sieger

POOL B

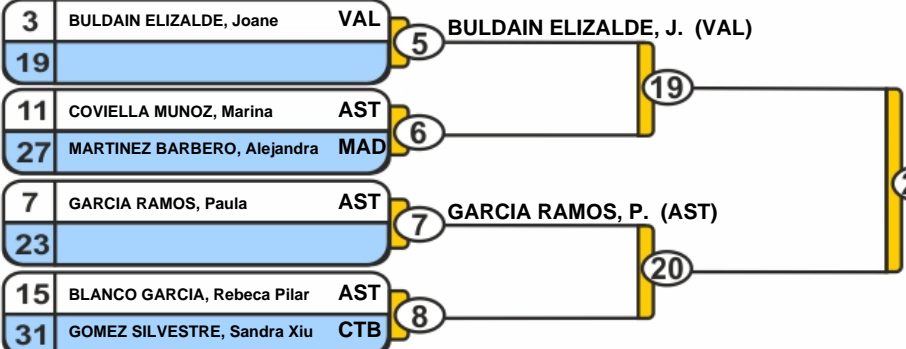

POOL B Winner / Ganador
Vainqueur / Sieger

POOL C

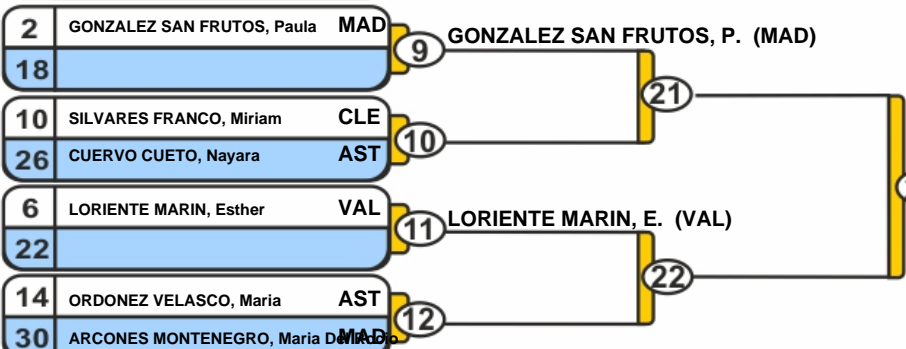

POOL C Winner / Ganador
Vainqueur / Sieger

POOL D

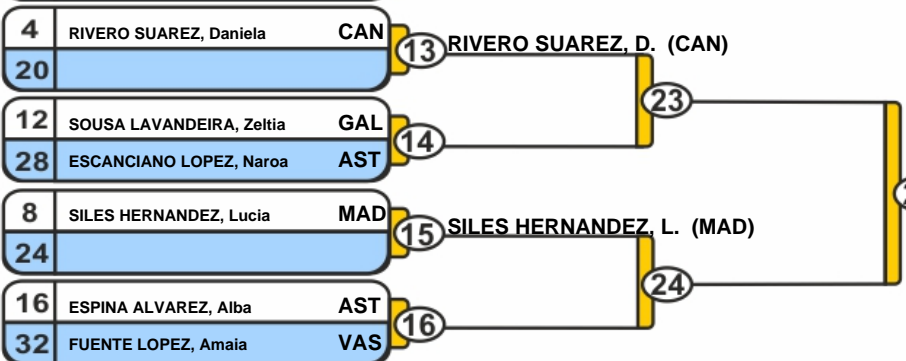

POOL D Winner / Ganador
Vainqueur / Sieger

1.

43

Results	
Résultat / Platzierungen / Resultados	
1.	
2.	
3.	
3.	
5.	
5.	
7.	
7.	

Trostrunde / Repechage / Ronda de consolación





Super Copa de Espana Junior Gijon 2023

Gijon (AST), 26 Nov 2023

-57 kg

29 Judoka

POOL A

1	ALBITOS LOPEZ, Carla	MAD	1	ALBITOS LOPEZ, C. (MAD)
17			17	
9	ARRIBAS SUAREZ, Claudia	AST	2	
25	MARTIN DE PIEDAD, Martina	CAN	2	
5	DEREWICKI, Bianca	AND	3	
21	NAVAJAS SECO, Nora	VAS	3	
13	TCHOFO HERMIDA, Nina	GAL	4	
29	BRAS, Raquel	POR	4	

POOL A Winner / Ganador
Vainqueur / Sieger

POOL B

3	MARTIN GIL, Aitana	VAS	5	
19	BURGOS SEGADE, Raquel	AST	5	
11	MARTINEZ MARTIN, Maria	GAL	6	
27	SAEZ HEVIA, Adriana	MAD	6	
7	PATINO MARTINEZ, Sara	GAL	7	
23	VIGUERAS USERO, Alba	ARA	7	
15	CABEZUDO NIETO, Adriana	CLE	8	
31	MIGUELEZ BRACCO, Maria	MAD	8	

POOL B Winner / Ganador
Vainqueur / Sieger

POOL C

2	PAZOS TRILLO, Lucia	GAL	9	PAZOS TRILLO, L. (GAL)
18			9	
10	FILIPE, Beatriz	POR	10	
26	GARCIA SOLERA, Natalia	MAD	10	
6	SUAREZ SANCHEZ, Bereket	CTB	11	
22	VILA GONZALEZ, Candela	GAL	11	
14	VIVES PUEYO, Martina	ARA	12	
30	ALVAREZ FERNANDEZ, Yanira	AST	12	

POOL C Winner / Ganador
Vainqueur / Sieger

POOL D

4	DOMINGUEZ BOSCH, Ingrid	CAT	13	DOMINGUEZ BOSCH, I. (CAT)
20			13	
12	TEJEDOR MORO, Nora	VAS	14	
28	TORRES IBARCENA, Isabel	MAD	14	
8	MINGOT LAPIEDRA, Aitana	VAL	15	
24	ALVAREZ PARIENTE, Elena	AST	15	
16	MARTINEZ BARBERO, Alicia	MAD	16	
32	SAMORAH LAKI, Kautar	GAL	16	

POOL D Winner / Ganador
Vainqueur / Sieger

Repechage

Trostrunde / Repechage / Ronda de consolación

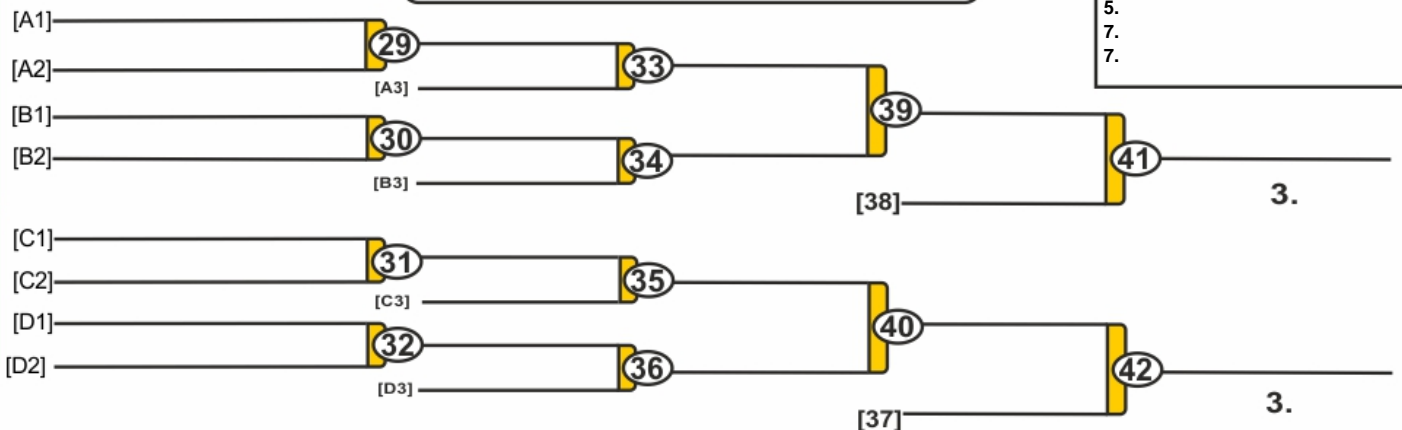

1.

43

Results

Résultat / Platzierungen / Resultados

- 1.
- 2.
- 3.
- 3.
- 5.
- 5.
- 7.
- 7.

3.

3.



Super Copa de Espana Junior Gijon 2023

Gijon (AST), 26 Nov 2023

-63 kg

29 Judoka

POOL A

1 SALAZAR RAMOS, Ainoa Angelina CAN ① SALAZAR RAMOS, A. (CAN)

17

9 LLOBET FRIGOLS, Berta VAL ②

25 PEREZ GARCIA, Alejandra AST

5 LOPEZ PEON, Alicia GAL ③

21 PUENTE MIRANDA, Carmen MAD

13 ARREGI HERNANDEZ, Nahia VAS ④

29 QUIROGA PEREGRINA, Sofia AST

3 CARPIO FERNANDEZ, Lucia MAD ⑤

19 FACEN, Carlotta CAN

11 PEREZ LIMIA, Ana Maria GAL ⑥

27 MAULEON DIAZ DE ALDA, Maialen VAS

7 VILLAMEDIANA JUNCAL, Leyre GAL ⑦

23 MORALES ROSIQUE, Claudia VAL

15 CONCHESO CORTINA, Aitana AST ⑧

31 MARTINEZ DE RITUERTO MORILLAN, M. De MAD

POOL B

2 CARPIO FERNANDEZ, Paula MAD ⑨ CARPIO FERNANDEZ, P. (MAD)

18

10 GARCIA SUAREZ, Leire AST ⑩

26 ANDRES DE CASTRO, Maria GAL

6 MARTIN GIL, Maria VAS ⑪

22 FERRAIRO RODENAS, Lorena VAL

14 LYSOGOR CHERKESOVA, Natalia MAD ⑫

30 SANCHEZ TABOADA, Nuria GAL

4 VAZQUEZ FERNANDEZ, Irene GAL ⑬ VAZQUEZ FERNANDEZ, I. (GAL)

20

12 PARDO ACHUCARRO, Adriana VAS ⑭

28 CARAZO LACUNZA, Andrea MAD

8 MARTINEZ DE RITUERTO MORILLAN, M. De MAD ⑮

24 LOPEZ COLOMA, Paula AST

16 SUAREZ GARCIA, Adriana CAN ⑯

32 RIVEIRO BECERRA, Lucia GAL

POOL C

POOL D

Trostrunde / Repechage / Ronda de consolación

Repechage / Trostrunde / Repechage

[A1] ⑲

[A2] ⑳

[B1] ㉑

[B2] ㉒

[C1] ㉓

[C2] ㉔

[D1] ㉕

[D2] ㉖

[A3] ㉗

[B3] ㉘

[C3] ㉙

[D3] ㉚

㉛

㉜

㉝

㉞

[38]

[37]

1.

27

28

Results	
Résultat / Platzierungen / Resultados	
1.	
2.	
3.	
3.	
5.	
5.	
7.	
7.	

3.

3.



Super Copa de Espana Junior Gijon 2023

Gijon (AST), 26 Nov 2023

-70 kg

11 Judoka

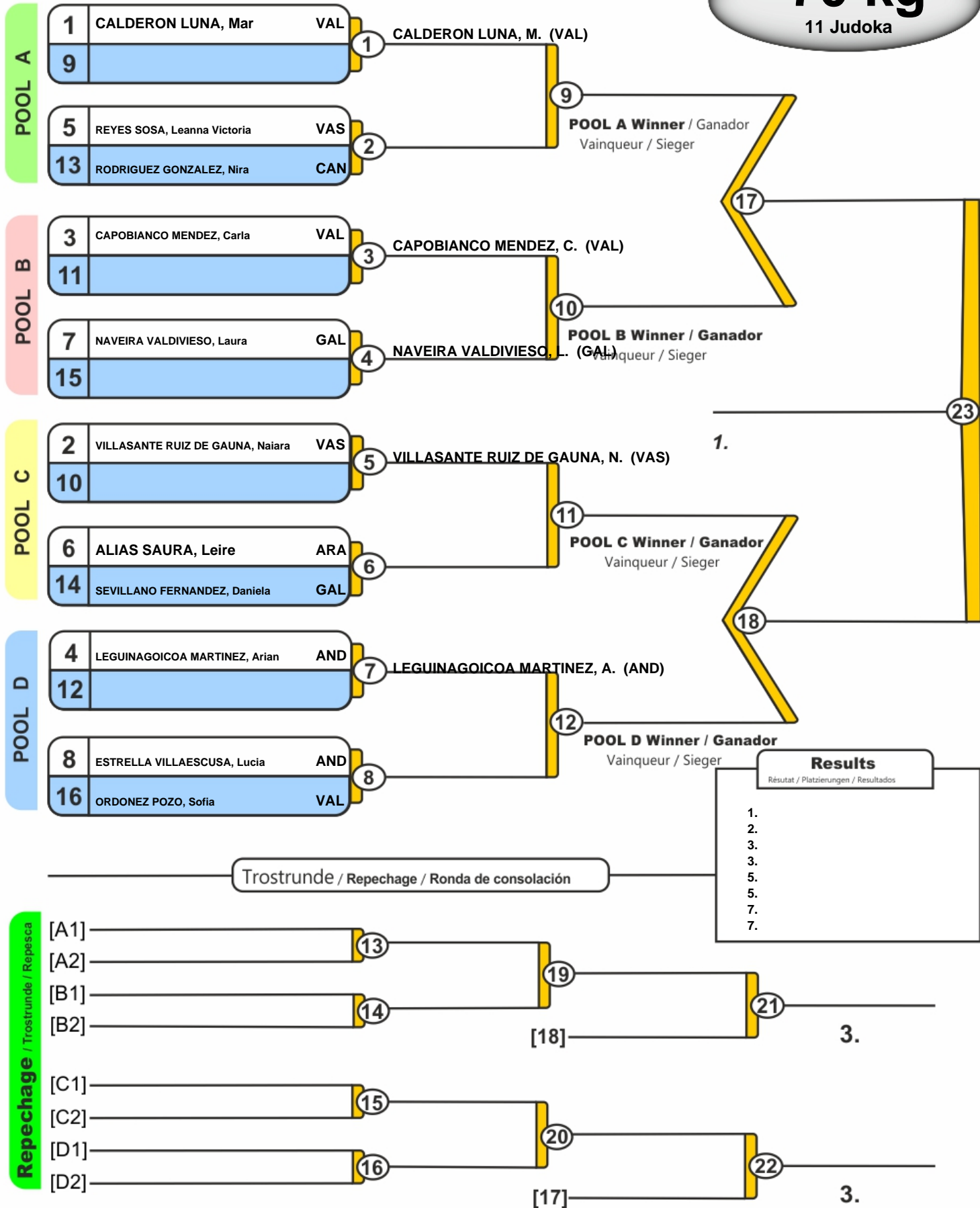



Super Copa de Espana Junior Gijon 2023

Gijon (AST), 26 Nov 2023

-78 kg

8 Judoka

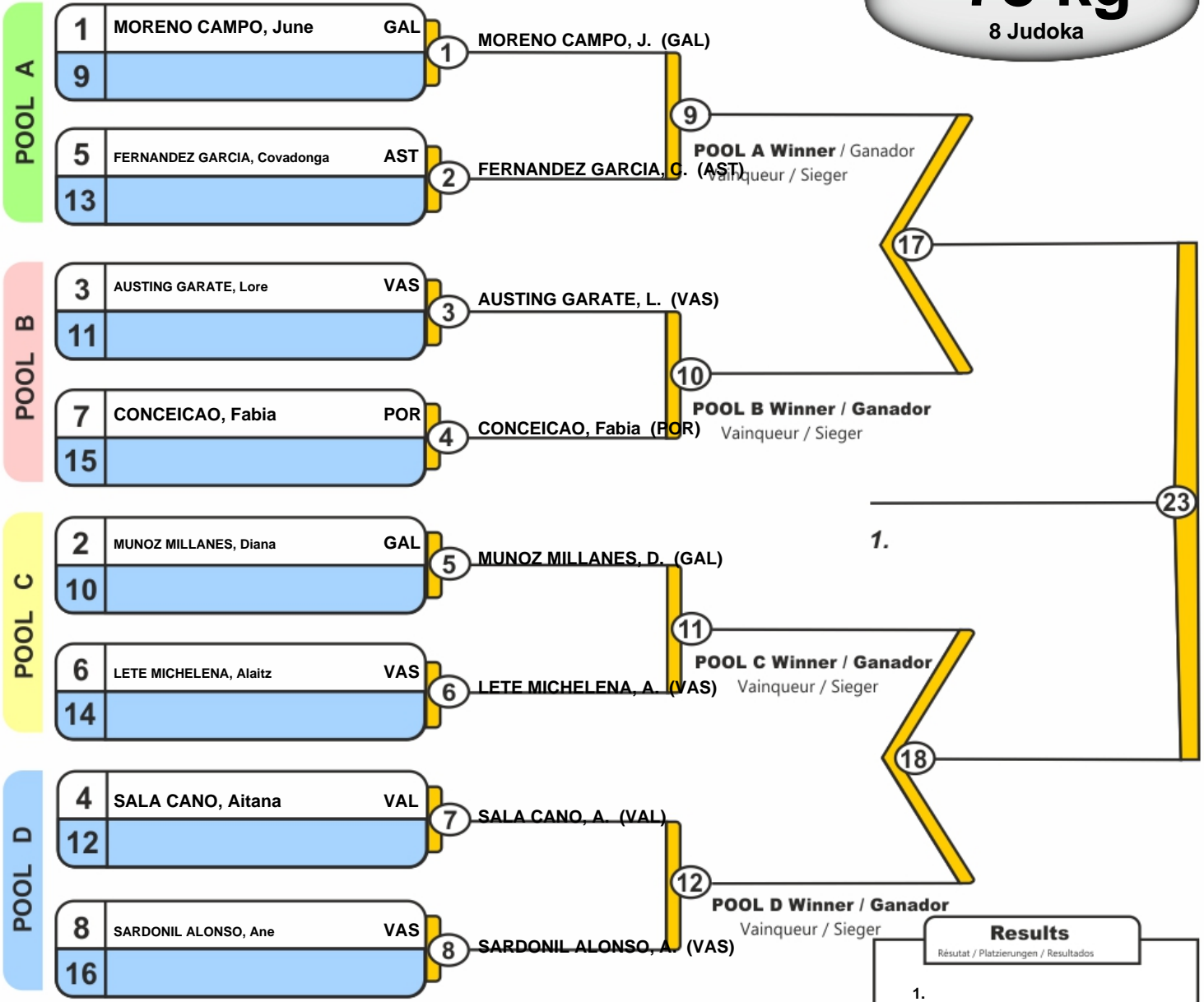

Trostrunde / Repechage / Ronda de consolación

Results	
Résultat / Platzierungen / Resultados	
1.	
2.	
3.	
3.	
5.	
7.	
7.	

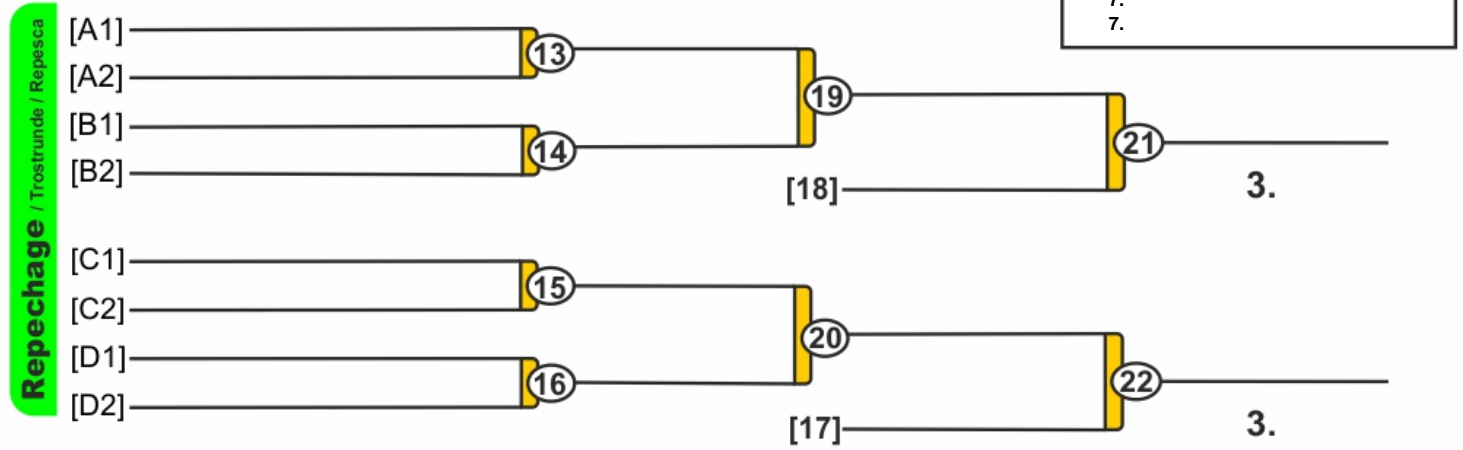



Super Copa de Espana Junior Gijon 2023

Gijon (AST), 26 Nov 2023

+78 kg

2 Judoka

Best of Three

1	GOYTIA CHAJTUR, Alejandra	RIO	1
2	DELGADO ROSADO, Naroa	VAS	

1	GOYTIA CHAJTUR, Alejandra	RIO	2
2	DELGADO ROSADO, Naroa	VAS	

1	GOYTIA CHAJTUR, Alejandra	RIO	3
2	DELGADO ROSADO, Naroa	VAS	



Final Results

- 1.
- 2.